

PRICE LIST 2024 OFFICE

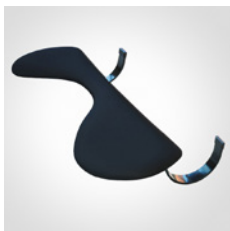

MATTING

CONTENTS



FLOOR PROTECTORS

Sida

STANDARD Floor protector	8
PREMIUM Floor protector	8
EARTH Floor protector textile	9
FOXTROT Floor protector textile	10
SOS Floor protector	11

FLOOR PROTECTORS with spike

STANDARD Mat protector	12
PREMIUM Mat protector	12

ERGONOMIC PRODUCTS/ACCESSORIES

CPU COMPUTER HOLDER	19
DOCUMENT HOLDER A3	13
CABLE BASKET	19
LAPTOP STAND MONITORSTAND	13
MOUSE PAD SOFTGEL	15
ERGONOMIC MOUSE TOUCH	16
KEYBOARD	17
KEYBOARD SLIM	17
KEYBOARD COVER	17
EXERCISE MAT	18
FOREARM SUPPORT ARMREST	14
FOREARM SUPPORT ARMREST ADVANCE	14
FOREARM SUPPORT ARMREST textile	14

LIGHTING

LISSABON desk lamp	20
MADRID desk lamp	21
NAPOLI desk lamp	22
SINGAPORE desk lamp	23
TOKYO desk lamp	24
VALENCIA desk lamp	25

BALL SEATS

BALANCE Ball seat	26
-------------------	----

SCREENS

SCREEN Desk screen	27
FOKUS Desk screen	28

PORTABLE MINI-DESKS

DESK CONVERTER	29
MINIDESK	30

Matting AB

Responsible design



LCA - Life Cycle Analysis

Matting uses life cycle assessment as an important tool in our early design process and product development phase. This is to make decisions based on the most accurate data we can to achieve the greatest and most far-reaching effects on longevity and reduced climate impact in the product's journey from cradle to cradle. If you want to know more about our work with LCA, you are welcome to contact us. Products with a completed life cycle assessment have this symbol.



EPD - Environmental Product Declaration

In parallel with LCA, there are EPDs based on the international standard ISO 14025. EPDs are third-party verified environmental declarations for products and consist of a PCR (product category rule) and an LCA. Products with an EPD have this symbol.



Dismantleable

To help reduce resource utilisation, we develop products that are easy to dismantle so that they can be easily returned to the circular flow. Products specifically designed for disassembly are labelled with this symbol.

Circular

For us, developing products equals great responsibility and creating new opportunities for future generations. In addition to innovative design, we focus on ensuring that our products can be easily reused for a long life over and over again with minimal waste. That the products have spare parts and can be easily repaired when long use has taken its toll on certain components. This symbol means that the product has replaceable parts for a long life and/or that we can offer service/services for updating/reusing the product.



Matting strives to reduce the proportion of virgin materials and minimise the use of raw materials. We therefore choose to use recycled materials in our products whenever possible. This symbol also indicates when a product contains at least 20% recycled material.



PVC-free

This symbol indicates that the product is PVC-free.

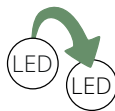

Replaceable LED

Several of our lamps have a replaceable LED (chip), for a long life and refer to lamps from new production. On most models you can change the chip yourself. Energy classification, our lamps have F and G, where F is equivalent to the previous labelling A+. The intention of the new classification is to create room for continued product development in the future, which means that at the changeover in March 2021 there were no products on the market in the most efficient energy class A.



OEKO-TEX

Matting works actively for sustainable, non-toxic production. Products marked with a STANDARD 100 by OEKO-TEX® have received global certification to show that the textile in the finished product is free from unhealthy chemicals. An evaluation for STANDARD 100 by OEKO-TEX® covers not only substances that are banned or have legally established limits but also other substances that have been scientifically proven to have, or can be suspected of having, adverse impact on health. The tests are performed by independent, leading OEKO-TEX® institutes.

Our range is continuously being developed throughout the year. Therefore, feel free to ask us for our latest new products or about projects involving our full range or unique customer-specific solutions. Prices are subject to change, E&OE.

Our vision

Matting's vision is to create well-being to prevent fatigue and encourage creative people.

Matting offers various solutions that create healthy workplaces and accessible environments. We aim to contribute towards a better world by always being daring, innovative, committed, proud and genuine.

Our story

Matting is a family-owned niche company. Matting AB was established in 1970 by Jon Botha and has become the Nordic region's leading supplier of high-quality ergonomic mats. During the last 10 years, Matting has invested in its own product development and developed strong concepts such as StandUp.

We are very intentional about using local production for as many of our products as possible, to reduce unnecessary transport and environmental impact, promote local labour and use natural, non-toxic materials.

Matting focuses on two main areas with concepts for a healthy workplace and active study environment and concepts with products and services for accessible, sustainable and safe environments.

StandUp & stay active - wherever you are

Our StandUp range is designed for the workplace of the future. Home offices, co-working spaces and activity-based or flexible offices. Yes, quite simply - wherever you are - no matter where your workplace is. All based on our passion to develop solutions that promote well-being and increased mobility.

The idea for our StandUp desk did not originate in the office - it came from our school environments. The series thus has several desk models, partitions and products that are adapted to create a modern and healthy study environment for our young people.

The design was developed and refined to meet our own stringent design requirements for products that we ourselves want to buy for our homes and our workplaces. The result is a locally produced flexible, slender, sleekly designed desk that is easy to move. With Scandinavian design and styling that works well in the home environment too. Produced in Sweden from sustainable, natural materials - without power consumption.



Our designers

Dan Ihreborn was born in Sweden in 1952 and has worked as a freelance designer since 1991. He works with modern furniture design and specialises in office environments as an interior designer. With his 45 years in the industry, Dan has extensive experience and understands how furniture has changed over the years.

Peter Mattisson comes from Borås. He began his professional career back in the 1970s, starting out at age 16 years as a trainee decorator. Since then, Peter has been active in the fashion industry and has worked in both fashion and interior design. He has worked as a designer since 2004 and, since 2015, has been running his own design agency, Peter Mathisson design.



Next Generation

Matting works actively to reduce the impact on future generations and on our environment. We have begun work to analyse the life-cycle of our products and to create circularity in our processes and products. To help our customers make sustainable environmental choices, we also calculate our products' climate impact.

Through all stages of production, we demand compliance with our Code of Conduct, and that products conform to the REACH regulation; we always strive to manufacture wooden products sustainably. We work on the basis of maintaining the highest quality requirements for our products. That's why we choose to have several of our products tested and certified by independent institutes such as Möbelfakta and OEKO-TEX.

Matting has been environmentally certified to conform to the ISO 14001 standard since 2001.

In our never-ending commitment to reducing our climate footprint and making it easier for our customers to live up to their environmental requirements, Matting has initiated the "LESS WASTE" packaging project. It is about reducing the number of packages as much as possible and reducing waste for the customer. Reducing packaging volume also reduces weight and emissions in transit.

Matting always ensures that our products meet the requirements of the REACH Regulation, which restricts the use of hazardous substances. Our lighting is CE marked and meets the requirements of the RoHS Directive. Matting fulfils the producer responsibility for recycling of electronics (WEEE) in accordance with Ordinance SFS 2014:1075.



ISO Certification

Matting AB has an environmental management system certified to ISO 14001:2015 and a quality management system certified to ISO 9001:2015

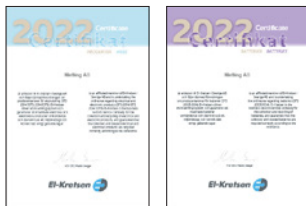

Collaboration with El-kretsen

Under regulation SFS 2014:1075 and the regulation on producer responsibility for batteries SFS 2008:834, we cooperate with Elkretsen AB in respect of producer responsibility for electrical and electronic products. Your used products can be left at the nearest recycling centre or collection point. For further information about the nearest reception station, visit www.el-kretsen.se

Sorting at source

Matting AB has a detailed recycling programme where we sort everything from household waste to wooden pallets.

Packaging materials

Packaging material is a significant, environmental impact factor in Matting's operations. In general, paper and packaging materials are made in Sweden in accordance with standards set by the Swedish Paper Industry Work Environment Council (PIA). All outer packaging used by Matting comes from 100% recycled paper. The packaging also bears the RESU label, a European label approved for European dimensions.



Member of the FTI register

Matting AB is affiliated with FTI, www.ftiab.se (in 2024, FTI's producer responsibility activities and expertise will be transferred to the newly formed company Näringslivets Producentansvar). We pay packaging fees and thereby shoulder responsibility for the recycling of our packaging.

Warranty

Our products must be of high quality, must be designed to function in a circular process, and must be durable. That's why we have a 5-year guarantee on our desks, storage furniture and the NEOS range. The rest of our range is backed by at least a 2-year manufacturing and production warranty. The warranty covers production and manufacturing defects. This does not cover normal wear and tear, damage or poor maintenance. The warranty period starts from the invoice date.

Prices

All prices are exclusive of VAT and shipping. We reserve the right, without prior notice, to make price adjustments resulting from changes in commodity prices, exchange rates, clerical errors or other circumstances beyond the control of Matting AB.

Small order charge

We apply a small order charge of SEK 200 for net orders less than SEK 500.

Terms and conditions of payment

Usually 30 days' credit up to an agreed limit following approved credit checks. Matting AB reserves the right to change the credit limit at any time and without notice. In the event of late payment, interest will be charged on arrears and, where applicable, a fee for collection and the payment order.

Delivery time

Delivery time on stocked standard products:

Orders are shipped from Matting's warehouse the next working day, unless the customer requests otherwise.

Delivery time for stocked products that require cutting, trimming or other customisation is 3-5 days.

Delivery times for non-stocked on-demand products vary and are given as per a separate delivery notification.

Shipping

Shipping costs are additional. Order delivered free ex-Mattings warehouse Alingsås. We deliver domestic shipments by DHL, unless otherwise agreed. Any free shipping limit is calculated in relation to the order value of the stocked range separately and the on-demand range separately, as simultaneous delivery dates are not possible. Packaging costs as of 1 July 2022.

Packaging costs invoiced in connection with deliveries on pallets:

EUR pallet: 22,50 €*

Disposable pallet, full: 12,50 €

Disposable pallet, half: 10 €

Pallet collar: 12,50 €

Pallet packaging: 12,50 €

**Does not apply to customers who are members of DHL's pallet pool.*

Complaints and returns

Each return and unit must be individually approved by Matting AB. For help, please contact us at info@matting.se or on tel. +46 322 670800.

Information concerning return possibilities for batteries, electrical and electronic products:

In accordance with the Ordinance on producer responsibility for electrical and electronic products (SFS 2014:1075) and the Ordinance on producer responsibility for batteries (SFS 2008:834), Matting AB offers to receive used products free of charge to ensure that the product is recycled or processed in an environmentally acceptable manner. The used product can be handed in to:

Matting AB
Tomasgårdsvägen 19
SE-441 39 Alingsås

Any costs incurred in connection with the return transport of the product are not refunded.



H 1.8
W 1000/1200/1200
D 1200/1500/2000

H 2.1
W 900/1200/1200
D 1200/1500/1800



STANDARD and PREMIUM floor protectors

STANDARD and PREMIUM floor protectors made of transparent, eco-friendly, non-toxic and recycled PET. Each floor protector contains recycled PET equivalent to as many as sixty 0.5-litre PET bottles. The floor protector has an anti-slip backing. Materials: Recycled PET.

STANDARD floor protector

Dimensions (mm)	Colour	Article no.	Price
1000 x 1200 x 1.8	Transparent	517120	73
1200 x 1500 x 1.8	Transparent	517216	102
1200 x 2000 x 1.8	Transparent	520720	121

PREMIUM floor protector

PREMIUM floor protection is a thicker (2.1 mm) version of STANDARD with the same properties and materials.

Dimensions (mm)	Colour	Article no.	Price
900 x 1200 x 2.1	Transparent	517090	87
1200 x 1500 x 2.1	Transparent	517117	130
1200 x 1800 x 2.1	Transparent	517122	147



H 5
W 1330
D 1500



EARTH floor protector

EARTH floor protector is a high quality textile chair pad with a langetted edge. A floor protector protects floors from wear and tear and dirt. Earth floor protectors are suitable for both public and domestic environments.

Our textile floor protectors are easy to care for as they are dense, durable and easy to vacuum. The 100% polyamide yarn makes it durable and suitable for office chair wheels. The cover is lightly striped.

Material: Pile 100% Polyamide, backside Actionback.

Dimensions (mm)	Colour	Article no.	Price
1330 x 1500 x 5	Mocca	521025	360

It holds the GUT label, guaranteeing that the textile floor protector meets necessary health, safety, and environmental standards.



Mocca



FOXTROT floor protector

FOXTROT floor protector is a high-quality textile chair mat with blanket-stitched edge. A floor protector protects floors from wear and soiling. Materials: Textile.

Dimensions (mm)	Colour	Article no.	Price
1330 x 1600 x 6	Grey/black	517355	310

H 6
W 1330
D 1600

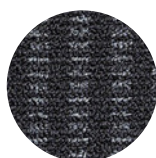

Grey/black

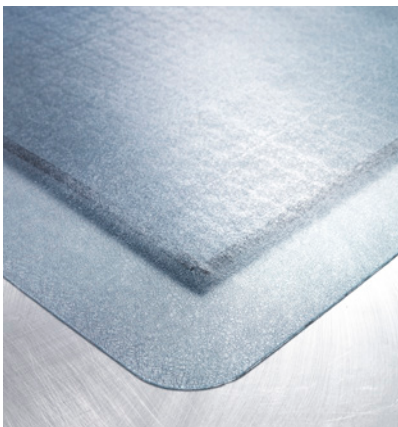

H 11.5
W 1200
D 1500

SOS floor protector

SOS floor protector combines floor protection with an ergonomic anti-fatigue workplace mat. Used for height adjustable desks where you can interchange between standing and sitting. In addition to protecting the floor, the floor protector allows castors to roll more freely and the workplace mat gives improved ergonomics for standing. Materials: Recycled PET, phthalate-free vinyl, Zedlan

Dimensions (mm)	Colour	Article no.	Price
1200 x 1500 x 11.5	Black/transparent	521000	323

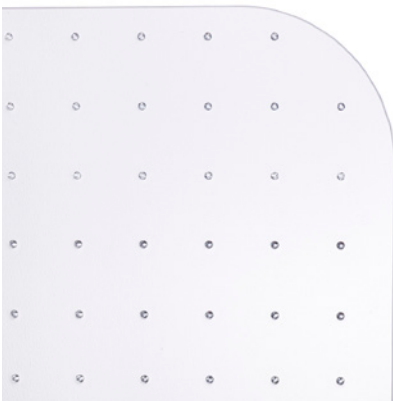

H 1.8
W 1000/1200/1200
D 1200/1500/2000
SPIKE 2.5



H 2.1
W 900/1200/1200
D 1200/1500/1800
SPIKE 2.5



STANDARD and PREMIUM mat protectors

STANDARD and PREMIUM mat protectors made of transparent, eco-friendly, non-toxic and recycled PET. Each floor protector contains recycled PET equivalent to as many as sixty 0.5-litre PET bottles. The floor protector has an anti-slip backing. Materials: Recycled PET.

STANDARD mat protector with spikes

Dimensions (mm)	Colour	Article no.	Price
1000 x 1200 x 1.8	Transparent	518220	87
1200 x 1500 x 1.8	Transparent	518215	118
1200 x 2000 x 1.8	Transparent	518295	139

PREMIUM mat protector with spikes

PREMIUM mat protection is a thicker (2.1 mm) version of STANDARD with the same properties and materials.

Dimensions (mm)	Colour	Article no.	Price
900 x 1200 x 2.1	Transparent	617090	98
1200 x 1500 x 2.1	Transparent	617117	147
1200 x 1800 x 2.1	Transparent	617122	165



H 80/130
W 580
D 210

MONITOR STAND laptop stand

MONITORSTAND laptop stand is suitable for both laptops and monitors, and also creates extra space on your desk. The monitor stand is stylish and can be set to two different heights. Materials: Glass, metal, plastic.

Dimensions (mm)	Colour	Article no.	Price
580 x 210 x 80/130	White	505440	48



D 247
W 422

DOCUMENT A3 document holder

DOCUMENT is an adjustable document holder in powder-coated metal for an ergonomically correct neck position. Takes up to A3 format. Magnetic ruler for variable adjustment. Materials: Steel, polypropylene.

Dimensions (mm)	Colour	Article no.	Price
422 x 247	Silver	606129	98



K 15
L 660
S 200 (60)

ARMREST support

ARMREST relieves the forearm and prevents ‘mouse arm’ as well as tension in the neck/shoulders. The asymmetrical design makes the armrest compatible with most ergonomic mice. Fits both straight and angled desktops. The PU leather surface layer can be sanitised. Easy to fit. Adjustable mounting. Materials: PU leather, foam rubber, MDF, sheet metal, metal.

Dimensions (mm)	Colour	Article no.	Price
660 x 200 x 15	Black	505100	158

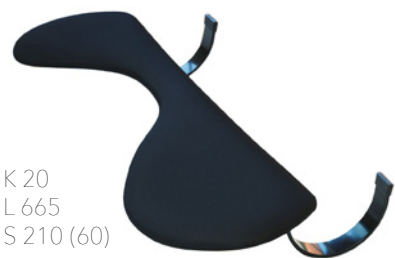

K 20
L 665
S 210 (60)

ARMREST ADVANCE forearm support

ARMREST ADVANCE supports the forearm and prevents ‘mouse arm’ as well as tension in the neck/shoulders. The asymmetrical design makes the armrest compatible with most ergonomic mice. Fits both straight and angled desktops. Surface layer made of dirt-repellent lycra textile or faux leather for easier cleaning. Easy to fit. Adjustable mounting. Materials: Lycra, foam rubber, MDF, sheet metal, steel.

Dimensions (mm)	Colour	Article no.	Price
665 x 210 x 20	Black, Lycra textile	505408	158
665 x 210 x 20	Black, faux leather	505411	158



K 25
L 560
S 220 (153)

ARM REST textile forearm support

ARMREST relieves the forearm and prevents symptoms such as ‘mouse arm’ and tension in the neck/shoulders. Fits both straight and angled desktops. Surface layer made of dirt-repellent Lycra textile. Easy to fit. Adjustable mounting. Material: Lycra, foam rubber, MDF, metal.

Dimensions (mm)	Colour	Article no.	Price
560 x 220 x 25	Black	505560	158



SOFTGEL mouse pad

SOFTGEL is an ergonomically designed mouse pad. The gel-filled wrist rest provides extra support and prevents 'mouse arm'. Friction-free Lycra surface provides maximum precision. Materials: Lycra, gel.

Dimensions (mm)	Colour	Article no.	Price
230 x 260 x 25	Black	653002	31



H 14-27
W 441
D 125

TOUCH ergonomic mouse pad

TOUCH has a sleek design. It provides an ergonomically correct working position. The smooth surface of the trackpad has smart functions with both zoom and touch function. Smooth surface for durability and easy of cleaning/sanitising. USB connection. Plug and play. Materials: Aluminium, PUR, electronics.

Dimensions (mm)	Colour	Article no.	Price
441 x 125 x 14-27	Silver	500201	343



H 20
W 441
D 124

KEYBOARD SLIM keyboard

KEYBOARD SLIM is an extra-slim keyboard. Thin, sensitive keys with Nordic keyboard layout. Fits TOUCH. Plug and play. Connection via USB. Compatible with Windows and OS X. Materials: ABS plastic, electronics.

Dimensions (mm)	Colour	Article no.	Price
441 x 124 x 20	Black	508102	58
441 x 124 x 20	Silver	508103	58



H 24
W 443
D 163

KEYBOARD keyboard

KEYBOARD is a quality keyboard. Nordic keyboard layout. Seven preset buttons for the most common multimedia functions. Fits ROLL-BAR: Plug and play. Connection via USB. Compatible with Windows and OS X. Materials: ABS plastic, electronics.

Dimensions (mm)	Colour	Article no.	Price
443 x 163 x 24	Black	508100	63

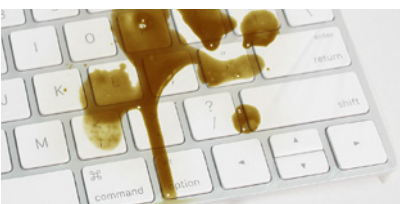

KEYBOARD keyboard cover

KEYBOARD keyboard cover is a thin keyboard cover made of durable, malleable plastic film. Easily to stretch over the keyboard to reduce the spread of infection and to protect against dirt and spills. Easy to replace. Latex-free. Materials: TPU

Dimensions (mm)	Colour	Article no.	Price
150-240 x 400-500	Transparent	508635	21

**EXERCISE mat**

StandUp EXERCISE mat in natural cork and natural rubber. The mat is 3 mm thick. The cork surface provides a good grip. Materials: Cork, natural rubber.

Dimensions (mm)	Colour	Article no.	Price
1830 x 610 x 3	Cork	551120	97



CPU computer holder

The CPU-holder places the tower computer under the desk. Adjustable width-ways and in height to accommodate different sizes and shapes of computer. Quick and easy assembly. Also suitable for desks with turned-up edges. Materials: Metal, textile.

Product	Colour	Article no.	Price
CPU computer holder, adjustable	Silver	500990	89

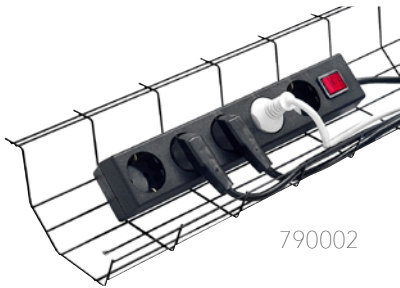

WIRE CABLE cable basket

Metal wire cable tray in various widths and lengths to help to store cables under the desk. Materials: Metal.

Dimensions (mm)	Colour	Article no.	Price
490 x 150 x 80	Black	790005	23
720 x 150 x 80	Black	790002	25
790 x 105 x 65	Silver	105060	26
790 x 105 x 65	Black	105065	26
790 x 185 x 105	Silver	185100	28
790 x 185 x 105	Black	185105	28

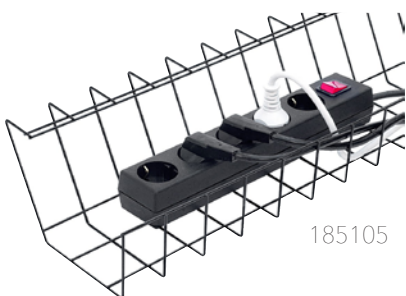
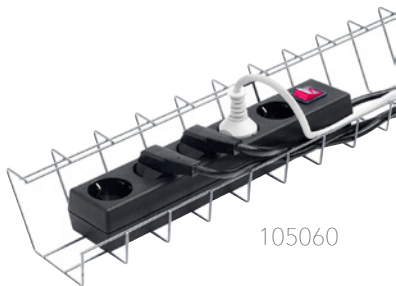

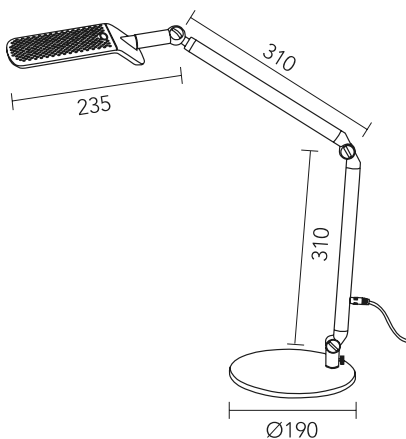

LISSABON desk lamp

LISSABON is a functional, practical and stylish desk lamp. The lamp is flexible and can be rotated in all directions. Slim, slender table base. Materials: Aluminium, plastic, metal.

Output/light source/luminous flux: 8W LED 670 lumens
Energy efficiency: 80 lumens/watt
Colour temperature: 3000 K
Colour reproduction: 80 Ra
Lighting intensity: 1500 Lux (40 cm)
Energy efficiency class: G
Dimmer: Stepless touch

Model	Colour	Article no.	Price
LISSABON	Black	775925	119
Optional extras	Colour	Article no.	Price
LISSABON clamp	Black	775940	22

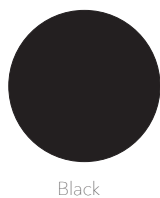



MADRID desk lamp

MADRID with COB LED technology is a desk lamp with a wide reach and a powerful beam. Lamp head and base in stylish, square design. Smart 4-stage touch dimmer on the lamp head. Materials: Aluminium, plastic.

Output/light source/luminous flux: 8W LED 700 lumens, replaceable LED
Energy efficiency: 110 lumens/watt
Colour temperature: 3000 K
Colour reproduction: 80 Ra
Lighting intensity: 1700 lux (40 cm)
Energy efficiency class: F
Dimmer: 4-stage touch dimmer



Model	Colour	Article no.	Price
MADRID	White	775927	204
MADRID	Black	775928	204
Optional extras	Colour	Article no.	Price
MADRID clamp	White	775827	28
MADRID clamp	Black	775828	28

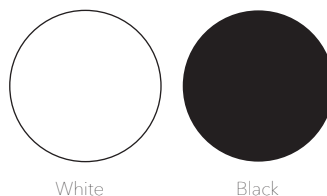
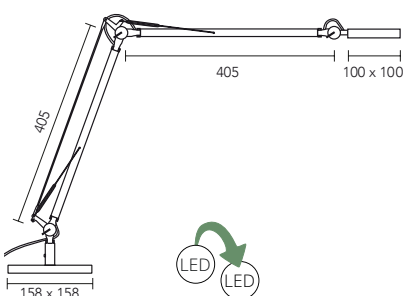

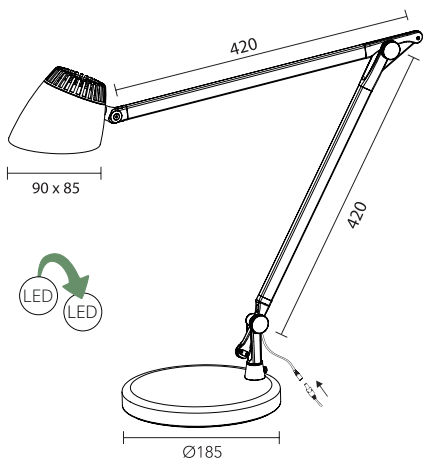

NAPOLI desk lamp

NAPOLI is an asymmetrical desk lamp that sets the bar high for functionality and design. Energy-saving option to select timed automatic shutoff. The buttons are cleverly located on the underside of the lamp head. Materials: Steel, aluminium, plastic.

Output/light source/luminous flux: 6W LED 550 lumens, replaceable LED
Energy efficiency: 85 lumens/watt
Colour temperature: 3100 K
Colour reproduction: 80 Ra
Lighting intensity: 1970 Lux (40 cm)
Energy efficiency class: F
Dimmer: 3-stage touch dimmer
Hours: 2, 4 and 9 hours

Model	Colour	Article no.	Price
NAPOLI with foot	White	775822	203
NAPOLI with foot	Silver	775821	203
NAPOLI with foot	Black	775820	203
NAPOLI with clamp	White	775922	193
NAPOLI with clamp	Silver	775921	193
NAPOLI with clamp	Black	775920	193

Optional extras	Colour	Article no.	Price
Clamp	White	775759	23
Clamp	Silver	775760	23
Clamp	Black	775761	23

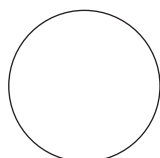

White



Silver



Black



SINGAPORE desk lamp

SINGAPORE desk lamp with adjustable light for the correct circadian rhythm (CCT). Small, collapsible multi-function lamp. Materials: Aluminium, plastic.



Output/light source/luminous flux: 7W LED 420 lumens
Energy efficiency: 75 lumens/watt
Colour temperature: Four different colour temperatures: 2900, 3400, 4100, 5000K
Colour reproduction: 80 Ra
Lighting intensity: 0-1020 Lux (40 cm)
Energy efficiency class: G
Dimmer: Variable dimmer
Charging function: Qi charging, USB charging

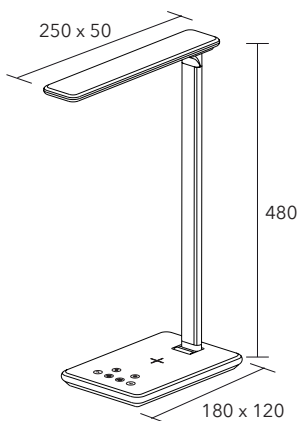

Model	Colour	Article no.	Price
SINGAPORE	Black	775740	117
SINGAPORE	White	775741	117

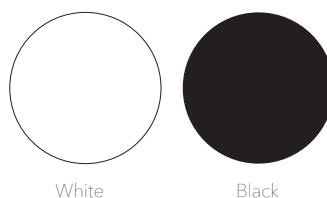

White

Black

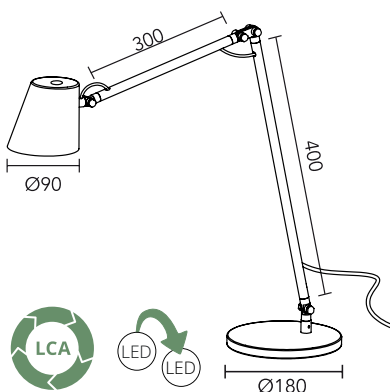

TOKYO desk lamp

TOKYO with COB LED technology provides plenty of light despite its slender design. A black lamp with gold-coloured reflector on the inside of the shade that gives a warm, comfortable working light. Design with raw details in black nickel. Available with table base or clamp. Materials: Iron, aluminium.

Output/light source/luminous flux: 9W LED 470 lumens, replaceable LED
Energy efficiency: 95 lumens/watt
Colour temperature: 3000 K
Colour reproduction: 90 Ra
Lighting intensity: 3010 Lux (40 cm)
Energy efficiency class: F
Dimmer: 3-step variable

Model	Colour	Article no.	Price
TOKYO with table base	Black	775806	175
TOKYO with clamp	Black	775807	175

Optional extras	Colour	Article no.	Price
TOKYO Clamp	Black	775809	20

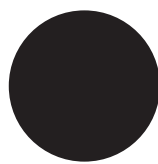

Black



VALENCIA desk lamp

VALENCIA is an asymmetrical desk lamp for workplaces where functionality and design are key. Materials: Steel, aluminium, plastic.

Output/light source/luminous flux: 6W LED 530 lumens, replaceable LED
 Energy efficiency: 85 lumens/watt
 Colour temperature: 3100 K
 Colour reproduction: 80 Ra
 Lighting intensity: 1800 Lux (40 cm)
 Energy efficiency class: F
 Dimmer: 3-stage variable touch dimmer
 Timer: 2, 4, 9 h

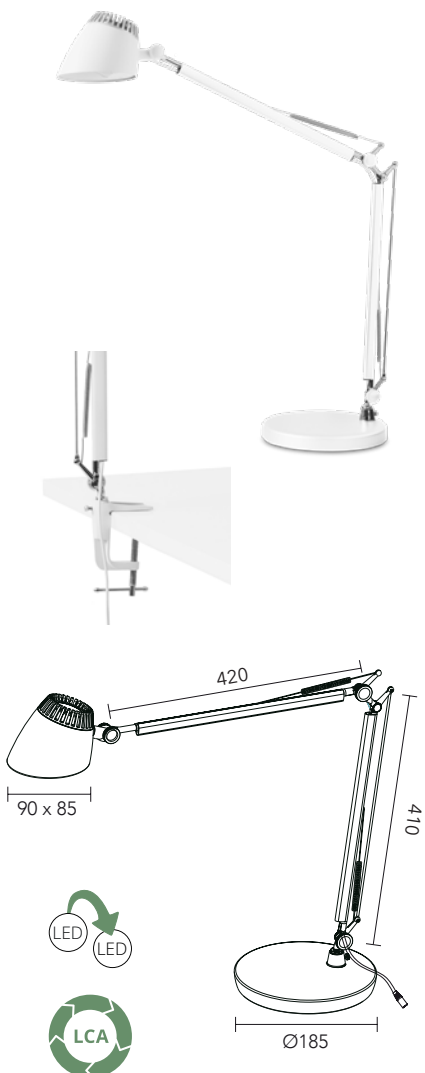

Model	Colour	Article no.	Price
VALENCIA with foot	White	775802	203
VALENCIA with foot	Black	775800	203
VALENCIA with clamp	White	775902	193
VALENCIA with clamp	Black	775900	193
Optional extras	Colour	Article no.	Price
Clamp	White	775759	23
Clamp	Black	775761	23

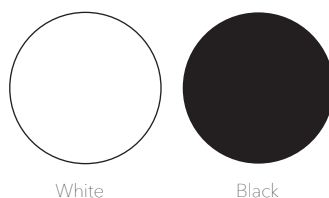



Ø650
Ø750

BALANCE sitting ball

StandUp BALANCE sitting ball for active sitting is available in several sizes, colours and fabric choices. The ball is PVC-free. In our Standard product range, BALANCE is available in OEKO-TEX-labelled Alcala fabric. Materials: Textile (Alcala), thermoplastic rubber (TPR). Design Peter Mattisson.

Dimensions (mm)	Colour	Item no.	Price
Ø650	Grey	551010	267
Ø650	Blue	551011	267
Ø750	Grey	551015	323
Ø750	Blue	551016	323
Fabric/manufacturer			Martindale
Alcala/Lechfabrics	OEKO-TEX		35,000

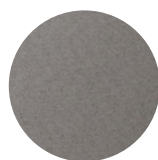

Grey



Blue



H 550 H 550
W 580 W 800
D 550 D 550

SCREEN desk screen

The StandUp SCREEN desk screen is a folding, sound-absorbing desk partition that can also be suspended. SCREEN comes as standard covered in OEKO-TEX certified fabrics - Hush and Alcala. SCREEN has a stable, recyclable corrugated plastic core. Materials: Textile (Hush and Alcala), corrugated plastic.

The 80-cm size fits our 96-cm or larger desktops and the 58-cm size fits our 70-cm desktops.

Dimensions (mm)	Colour	Item no.	Price
580 x 550 x 550	Grey/Orange	801021	154
580 x 550 x 550	Grey/Green	801022	154
580 x 550 x 550	Grey/Grey	801023	154
580 x 550 x 550	Grey/Blue	801024	154
800 x 550 x 550	Grey/Green	801032	194
800 x 550 x 550	Grey/Grey	801033	194
800 x 550 x 550	Grey/Blue	801034	194
Fabric/manufacture		Other	Martindale
Hush/Gabriel and Alcala/Lechfabrics		OEKO-TEX	25,000/35,000



Grey/orange

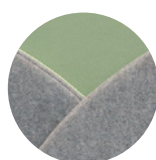

Grey/green



Grey/grey

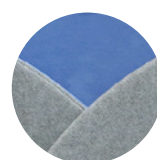

Grey/blue



FOCUS desk screen

StandUp FOKUS desk screen is a durable, attractive folding desk screen made from pressed, ribbed, recycled PET. FOKUS has an eyelet for easy hanging. Materials: PET fibre/ribbed.

Dimensions (mm)	Colour	Article no.	Price
550 x 517 x 530	Anthracite	801045	98



H 530
W 550
D 517



Anthracite



Small
H > 61-400
L 650
W 400

Large
H > 55-410
L 780
W 520

DESK CONVERTER

Jobmate DESK CONVERTER is a folding height-adjustable desk, available in two different sizes. The working height is variably adjustable with a gas spring and is easy to set to the correct working height. Folds and stows away easily. Materials: MDF, steel, plastic.

Dimensions (mm)	Model	Colour	Article no.	Price
650 x 400	Small	White	809783	67
650 x 400	Small	Black	809782	67
780 x 520	Large	White	809781	84
780 x 520	Large	Black	809780	84

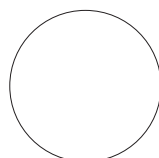

White

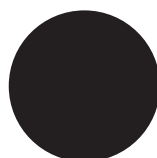

Black



MINIDESK

StandUp MINIDESK folding height-adjustable desk is a high-quality, portable desk. Made in Sweden with six different working modes. Great for the home office or co-working surface, etc. Folds and stows away easily. Materials: High-pressure laminate, particleboard, steel, polyamide. Design by Dan Iherborn.



H > 240-490
L 750
W 600

Dimensions (mm)	Colour	Article no.	Price
750 x 600	White	809581	195
750 x 600	Black	809580	195

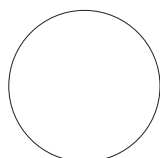

White

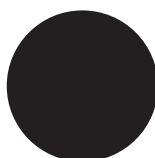

Black